

Instructions



Shaker VIBA X.30

Keep this manual within immediate
reach of the machine

Translation of the original instructions -en English



Contents

1. Layout Drawings	4
1.1 Machine components	4
1.2 Operating and display components	5
2. About this document	6
2.1 Pictograms and symbols	6
3. For your safety	7
3.1 General Safety Information	7
3.2 Intended Use	7
3.3 Foreseeable Misuse	8
3.4 Qualifications of operating personnel	8
3.5 Safety-relevant components	9
3.6 Residual Risks	9
4. Equipment Description	9
5. Set-up and using the Shaker for the first time	10
5.1 Content	10
5.2 Set-up the equipment	10
5.3 Mains connection	10
5.4 Trial run	11
5.5 Transport	11
5.6 Attach transport lock	11
6. Operation	12
6.1 Switching on the machine	12
6.2 Load a container	12
6.3 Starting the mixing cycle	13
6.4 Ending the mixing cycle	13
6.5 End of work	13
6.6 EMERGENCY STOP switch	13
7. Errors and Troubleshooting	14
7.1 Possible errors	14
7.2 Unlock door manually	15
7.3 Fuses on the device	15
8. Maintenance	16
8.1 Cleaning	16
8.2 Service	16
8.3 Repair	17
8.4 Consumables	17
9. Storage, disposal	17
9.1 Storage	17
9.2 Disposal	17
10. Appendix	18
10.1 Technical Specifications	18
10.2 Dimensions	18
10.3 EC Conformity Declaration	19
10.4 Warranty	19

1. Layout Drawings

1.1 Machine components







Machine components

① Power supply and AC fuse	⑥ EMERGENCY STOP Switch
② Mixing table	⑦ Control unit
③ Clamping plate	⑧ Door
④ Manual door release	⑨ Loading shelf
⑤ Main switch and DC Fuse	⑩ Transport rollers

1.2 Operating and display components



	Button for DOOR	OPEN door
	Button E	OPEN the mixing unit STOP – stop mixing cycle prematurely ACKNOWLEDGE messages
	Button I	Mixing cycle I (Factory settings 0:30 mins.)
	Button II	Mixing cycle II (Factory settings 1:00 mins.)
	Button III	Mixing cycle III (Factory settings 2:00 mins.)

**The specified mixing times are factory settings and may vary by customer*

2. About this document

These instruction uses symbols and labels, which should make it easier for you to find information swiftly. Please read the explanations in the following Section. Please read the safety and warning information in these instructions especially carefully. Safety information is in Chapter 3. You find information on warnings in the introduction of Chapters and before instructions.

Collomix GmbH owns the copyright of images and text.



Please read the operating instructions prior to first use. Pay attention to safety instructions. Keep for future use. This documentation is not subject to change services.

In addition to the information in these operating instructions, the occupational safety and health regulations applicable at the place of use must be observed.

2.1 Pictograms and symbols

Warnings

The following symbols and signal words are used in this documentation.

Symbol	Meaning
DANGER 	This signal word is used, if death or severe physical injuries is the result of not paying attention to the corresponding precautionary measures.
WARNING 	This signal word is used, if death or severe physical injuries may result from not paying attention to the corresponding precautionary measures.
ATTENTION 	This signal word is used, if slight physical injuries occur from not paying attention to the corresponding precautionary measures.
CAUTION	This signal word is used, if malfunction of functions or property damages may occur from not paying attention to the corresponding precautionary measures.
IMPORTANT	This signal word is used for easing operation or for pointing to references.

Structure of warnings

DANGER

The first line describes the type and source of danger.

The second line describes the consequences which occur if no actions are taken to avert the danger.

→ The last line describes the actions to take in order to avoid the danger.



WARNING

Danger of injury through disregard of safety symbols



Ignoring the warnings on the equipment and in the operating instructions can lead to injuries and additional risks.

→ Pay attention to the warnings on the equipment and in the operating instructions.





The following special safety symbols are used in the appropriate text portions of these Operating Instructions.

Mandatory signs

Symbol	Explanation	Symbol	Explanation
	Please read the information		Disconnect from power
	Use protective gloves		

Warning signs

Symbol	Explanation	Symbol	Explanation
	Warning from a danger zone		Danger of electric shock
	Warning of danger due to crushing		

Position numbers to the illustrations are stated in parenthesis in the text.

3. For your safety

The machine was developed, manufactured, and tested in accordance with the basic safety requirements. Despite, there is an element of risk.

- Therefore, please read these Operating Instructions before working with the machine.
- Keep the Operating Instructions within immediate reach of the machine.
- Please hand the Operating Instructions to any subsequent owners.

3.1 General Safety Information

The basic safety information of this Chapter are supplemented by precise warnings in further chapters of the Operating Instructions.

3.2 Intended Use

The Collomix Shaker is intended to mix:

- Colours
- Colour granulate
- Façade colours
- Industrial colours
- Plaster

Any other or expanded use of the Shaker is a non-intended and therefore, improper use. In this case, the safety mechanisms and the protection provided by them may be compromised. Collomix GmbH is not liable for any damages caused by it. Part of the intended use are:

- complying with all information in these Operating Instructions
- complying with all safety information
- complying with the inspection and maintenance work

3.3 Foreseeable Misuse

Any reasonably foreseeable misuse, which can be hazardous for the user, third parties, or for the machine are:

- The use of the Shaker and its accessories contrary to the intended use.
- The use of damaged containers or containers not suitable for mixing.
- Operation in any areas where there is a potentially explosive atmosphere and mixing of explosive substances.
- The use of substances, which react chemically with one another; in particular, expanding substances.
- Mixing pressurized containers such as aerosol cans.
- The use of the equipment outside the limitations described in this instruction.
- The modification of the control software without the prior coordination with Collomix GmbH.
- Modifications on the machine or control software as well as add-ons and retrofits.
- The use of non-original replacement parts
- Operating the system contrary to the requirements of the Operating Instructions concerning safety information, installation, operation, servicing and maintenance, set-up, and malfunctions.

WARNING

Danger of injury through improper modifications

Hazards exist through unauthorized modifications to the system and the use of third party spare parts.

- Use only original spare parts and accessories of the manufacturer.
 - Do not change, add to, or retrofit the system without the consent of the manufacturer.
-



3.4 Qualifications of operating personnel

These Operating Instructions are directed toward operators and personnel with the following areas of competency:

Working area	Expertise
Installation and Commissioning	Specialised staff
Operation and Cleaning	Instructed staff
Service and Repair	Specialised staff

Instructed staff:

A person, who was instructed by an expert in the responsibilities he or she has been assigned and any possible hazards in case of improper behaviour and a person, who was trained in the necessary protective devices and protective actions, if needed.

Specialised staff:

Persons who can evaluate the work assigned to them and recognize possible dangers on the basis of their specialised training, knowledge, experience, and familiarity with the relevant norms.

3.5 Safety-relevant components

The machine is equipped with various safety devices. These help to avoid dangers to body and life through electrical and mechanical impacts on the persons working with the Shaker and they help to limit any material damages to the system.

- **Do not bypass, remove, or render ineffective the safety equipment.**
- **Do not operate the machine if the safety equipment is not complete or fully functional.**



Closed housing

The housing, which can only be opened with tools, forms a fixed, separating safety device.

Machine door with interlocking device ⑧

The door forms a locking, separating unit with interlocking device. The machine cannot be started when the door is open. The door is only released after the mixing process has ended and the mixing vessel is released. Never operate the machine if the machine door is damaged.

EMERGENCY STOP Switch ⑥

In emergencies, the EMERGENCY STOP function is used to stop the running machine if necessary.

3.6 Residual Risks

If all precautions are taken, there may be obvious residual risks. Adhering to the safety instructions, the designated use, and the operating instructions can reduce residual risks!

4. Equipment Description

The Shaker is a stationary mixing device for closed, tightly closing, round, angular, and oval vessels made of metal or plastic. It is suitable for mixing colours, colour concentrates, building and industrial lacquers, and other materials with low viscosity.

The area of application ranges from the colour wholesale to retail trade, the lacquer and chemical industry to any similar areas. This mixing device is especially suited as system component for colour dosing systems.

The container is automatically clamped into the machine and the substance is mixed by linear inertial forces using an alternating orbital shaking motion.

The necessary mixing time and the suitability of the containers must be determined by mixing trials prior to use.

5. Set-up and using the Shaker for the first time

The machine is intended for indoor use and is to be protected from the elements.

When choosing the installation site, ensure that there is sufficient lighting and a work surface in front of the machine. Machine parts must not protrude into aisles and walkways!

5.1 Content

The Shaker is delivered with the following:

- These Operating Instructions
- Cover insert made of foam
- A rubber band to secure the handles
- A power supply cord

5.2 Set-up the equipment

The machine is delivered on a wooden pallet packaged in recyclable cardboard. Check the packaging immediately upon receipt and the equipment when unwrapping it for any visual external defects. Keep all parts of the original packaging for a possible necessary return.

The machine shall be operated only by qualified personnel using suitable lifting equipment eg. a forklift truck to be lifted from the palette. Only move the fork in from the front or back to avoid damaging the transport rollers.

Pay attention to the weight of the machine specified in **11.1** not to exceed the permissible load of the floor.

Do not operate the machine on the shipping pallet or on any other unsuitable sub-surfaces.

In general, the machine does not need any fine adjustment because of its 3 legs. If necessary, you can adjust any unevenness in the floor with the height-adjustable legs.

To protect the mixing unit from damages during transport, it is secured with a lashing belt, which goes over the mixing unit. The belt must be removed prior to switching on the machine:

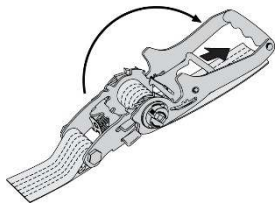

To release, pull the slider and move the lever by approx. 180° to the stop.

The pre-tensioning force is released immediately.

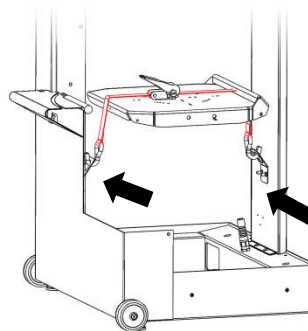

The strap is hooked into the attachment points in the machine.



Machine legs



Transport lock with lashing belt

5.3 Mains connection

Pay attention on proper protection of the electrical circuit such as described under **11.1** Only use Type B residual-current devices (RCD).

Place the mains cable in a way to prevent from stumbling or snagging.

5.4 Trial run

A trial run with an empty mixing container must be conducted when first starting the machine or after maintenance and repair work in order to check the proper function of the machine.

WARNING

Risk of injury due to protruding parts

Parts may protrude from the equipment.

- Always work diligently on the equipment and in close proximity of the equipment.
- If the machine is not used, close the door and turn it off on the main switch.



5.5 Transport

The equipment has two transport rollers ⑩ on the front side of the housing. These transport rollers allow to move the machine over short distances in an ergonomically user-friendly manner.

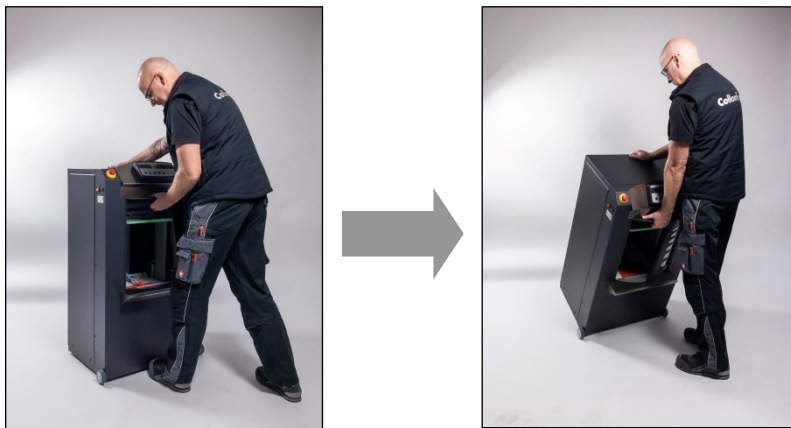

The door must be opened for the machine to be handled safely during transport. Secure the opened door with the hand against swinging.

5.6 Attach transport lock

The lashing strap must be inserted into machine during every transport of the machine otherwise the swinging mixing unit could damage the machine. Therefore, you need to keep the lashing strap for a later transport of the machine.

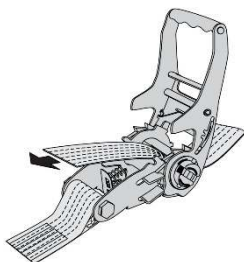

Thread the end of the strap into the shaft until the strap is tight.

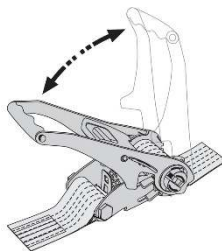

Tension the strap with the lever until the mixing unit reaches the lower limit stop.

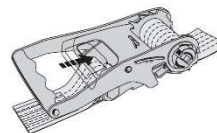

Move the lever into the locked position until the slider is engaged.



Front attachment



Rear attachment

6. Operation

Prior to working with the machine, check all parts for their proper condition and function. Do not start the machine with defective or missing parts.

Check all safety-relevant structural components of the machine for proper function before starting it. Any defective or damaged parts must be replaced by qualified personnel prior to starting to work with it.

6.1 Switching on the machine

The machine is turned on using the main switch (5). After an automatic initialisation, **START** is shown on the display.

Any errors detected during initialisation are shown in text form on the display.

6.2 Load a container

Only use sufficiently stable and tight-closing vessels for mixing. In case of doubt, consult the manufacturer of the mixing vessels.

To place the container, proceed as follows:

- Unlock and open the door (8) by pushing the **DOOR** button.
- To adjust the mixing unit to the height of the container, close the door and use the **E-Button** to raise the clamping plate (3).
- Place the container centrally on the mixing table (2).
- Observe the weight and size limits of the mixing vessel. Never overload the machine!
- Secure the container handle with a rubber band or an adhesive.
- Use only undamaged containers, never stack containers!
- Several identical containers can be mixed at the same time. Pay attention to a symmetric arrangement of the containers on the mixing plate.
- Close the door.



Securing the handle with a rubber band

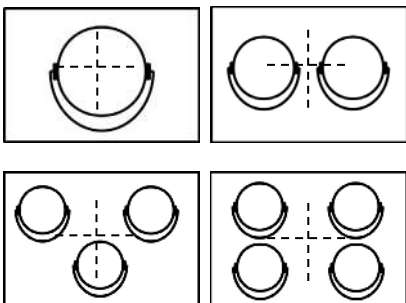

Place containers always in the centre.

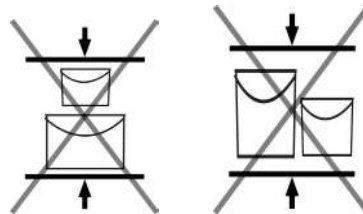

Do not stack containers!



Filler disk

IMPORTANT

If you use larger containers, it is recommended to insert an additional filler disk made of foam. However, the filler disk should not be higher than the rim of the cover. It reduces the membrane effect of the cover and the running noise is reduced.

WARNING

Crushing or shearing in the area of the mixing unit.

Risk of injury from crushing or shearing of limbs.

- Never reach into the mixing compartment during the clamping and unclamping process of the mixing unit!
- Keep the door always closed!
- Disconnect the machine from the power supply during cleaning or maintenance work!



6.3 Starting the mixing cycle

The mixing cycle can only be started after the door is closed.

Push buttons I, II, or III to start the mixing process. The corresponding mixing times are shown on the LD display above the key pad.

The mixing container is clamped into the machine and the mixing process is started. The remaining mixing time is displayed during the mixing process.

6.4 Ending the mixing cycle

After the selected time is over

The mixing process is automatically stopped. The mixing unit is opened, the door is opened by spring force, and the container can be removed. If necessary, the door ⑧ can be opened manually with the **DOOR** button.

Before the selected time is over

The mixing process can be stopped early by pushing the **E**-button.

6.5 End of work

When the machine is not in use, the door should be kept closed.

When done working, switch the machine off at the mains switch ⑤.

6.6 EMERGENCY STOP switch

In dangerous situations, the machine can be stopped with the EMERGENCY STOP switch ⑥.
After the machine is turned off, the mixing unit rotates until it comes to a stop in its position.

Reset the EMERGENCY STOP switch

The EMERGENCY STOP switch must be reset by hand.

- Rotate the red control element clockwise.
- After you reset the EMERGENCY STOP switch, reset the message in the display by pushing the **E**-button.
- The mixing unit loosens automatically, the door can be opened, and the container removed.

DANGER

Danger of death by dangerous voltage

There is a residual electrical energy in lines and equipment after the EMERGENCY STOP switch is used. The EMERGENCY STOP switch does not disconnect the machine from the mains voltage.

- If maintenance or repair work is carried out on the machine, always unplug the power cord.
-



7. Errors and Troubleshooting

The troubleshooting tables in this Chapter will help you to determine whether you can troubleshoot yourself or whether you need to call customer service.

IMPORTANT

Jot down the serial number of the machine and the error code from the display before you call customer service. The machine's serial number is on the type plate.

7.1 Possible errors

Fault	Description	Machine condition	Solutions
E010	Door open	• Door open	• Close door
		• Door closed	• Check the door lock • Check the power cord / plug to the door lock.
E020	EMERGENCY STOP activated	• EMERGENCY STOP button pushed	• EMERGENCY STOP button released
		• EMERGENCY STOP button not pushed	• Check the switch of the EMERGENCY STOP button • Check the power cord / plug to the EMERGENCY STOP button.
E025	Door unlocked	• Door does not engage	• Check the door lock
E030	Did not find the container	• No mixing container is placed	• Place mixing container
		• Mixing container is placed	• The mixing container is too small
E050	Defective container	• Container is defect	• Container is unstable
			• Check clamping pressure, if necessary adjust
E150	Error clamp motor	• The mixing container is not clamped	• Check the clamp motor • Check the lines to the clamp motor • Check the control
E160	Error rotary decoder	• The mixing unit does not clamp	• Check clamp motor • Check the lines to the clamp motor • Check the control
		• The mixing unit clamps	• Check the control
E170	Error door lock		• Close door completely
			• Check the door lock • Check the connection of the door lock
E180	Door not open	• The door is not open	• Open door with the DOOR button
		• The mixing container is clamped	• Check the door lock • Check the connection of the door lock • Check door motor
E220	G Sensor		• Container is too heavy or placed de centred • Check alignment of the machine
			• Check flange bearing and oscillating arms

The grey highlighted services can only be carried out by specialised staff.

7.2 Unlock door manually

The machine is equipped with a safety lock, which locks the door automatically after it is closed. In the event of a malfunction or power outage, the door can be unlocked manually.

- Disconnect the machine from the mains by pulling out the mains plug.
- Insert a screwdriver into the hole of the door release ④ and press downwards.
- The door opens automatically.



Door unlocking device

WARNING

Risk of injury by machine parts that continue to rotate

When activating the manual door release, the mixing process is interrupted automatically. The mixing unit will run for a few seconds up to a complete standstill.

- Use the manually door unlocking device only in case of emergency.
- Before using the manually door unlocking device, always disconnect the machine from the mains by pulling out the mains plug.
- Never use the manually door unlocking device whilst the mixing unit is turning.



7.3 Fuses on the device

7.3.1 Device fuse

If line voltage is available but the power button does not light up, the cause may be a faulty device fuse.

The device fuse is in the mains connection ① on the back of the machine. Only use 5x20mm, 230V/10AT fuses to replace a blown fuse.

If the device fuse is tripped again, there is a defect in the control unit. If this is the case, contact an authorised service partner to correct the error.



Device fuse

7.3.2 DC fuse

If the power button is on, but nothing is showing on the display of the operating unit, the cause may be a tripped DC fuse.

The DC fuse is located next to the power button ⑤. After the fuse is tripped, wait at least one minute, and only then press the pin back in until it locks into place.

If the device fuse is tripped again, there is a defect in the control unit. If this is the case, contact an authorised service partner to correct the error.



DC fuse

8. Maintenance

It is necessary to check, clean, and service the machine regularly to ensure continuous function.

Unplug the machine from power by pulling the plug before all cleaning, maintenance, and repair work is done on the machine.

Use protective gloves to avoid injuries on sharp edges when working inside the machine

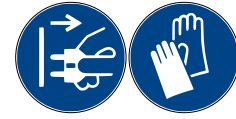

8.1 Cleaning

Remove any spilled mixed compound immediately from the interior of the machine. For this purpose, use a rag or a scraper. Be careful not to damage any connections or sensors.

Soiled threaded spindles can be cleaned with a rag or a wire brush. The threaded spindles must be re-lubricated with **Mobilux EP2** after cleaning.

CAUTION

Damage to the machine through wrong cleaning

- Never use solvent cleaning agents such as acetone, gasoline, or similar aggressive substances to clean the door window or the control panel. Such substances can corrode or even destroy plastic parts.
- Never clean the machine with a high-pressure cleaner or water hose! This washes out the grease lubrication of the ball bearings and promotes corrosion.



8.1.1 Wöchentliche Reinigungsarbeiten

- Check the mixing table ② and clamping plate ③ for contamination and clean if necessary.
- Check the function of the door ⑧. Free the door guide from paint residues so that the door glides slightly and snaps into place.
- Check handle protection for wear and damage, replace it if necessary.

8.2 Service

Only qualified personnel may carry out maintenance and repair work. Use only original replacement parts.

8.2.1 Annual service

- Clean the threaded spindles and lubricate with Mobilux EP2.
- Check the outer flange bearings and swing arms for damages.
- Check the drive belt for wear and tear and adjust the belt tension if needed.
- Check the clamping plate ③ for wear and tear. Replace if needed.

8.2.2 Runtime-dependent service

Drive belts and flange bearings of the mixing unit must be replaced by an authorized service technician every 30,000 mixing cycles but no later than after 1,000 operating hours.

The number of cycles and the operating hours are shown on the LC display of the operating unit during the initialization after the machine is turned on.



Handle protection

8.3 Repair

If service is required, please consult the customer service or the manufacturer of the machine.

DANGER

Danger of death by dangerous voltage

Do not open the housing or remove any safety equipment of the machine. Please note that all maintenance and servicing jobs must be left strictly to authorized and suitably trained expert staff. The proper state of all safety equipment and electrical equipment is to verify and document after the repair.



- Only use original spare parts.
- Do not modify or change safety-related parts!
- Any additional components added may not impair safety and must be approved by the manufacturer.

8.4 Consumables

The following parts are available for the device:

Part	Article no.:
Cover insert 20 mm (set has 5 pieces each)	74088
Cover insert 5 mm (set has 5 pieces each)	74136
Handle fixation	64447
Mobilux EP2 100g	61299

Spare parts are available at www.collomix.de.

9. Storage, disposal

9.1 Storage

The storage area should be cool and dry in order to prevent corrosion on the individual parts of the machine.

The room temperature of the storage area must be constantly above freezing.

- Package the device to prevent any damages through outside impacts during storage.
- If necessary, use cardboard and other packaging material.
- Secure the machine against unintentional tilting and instability.

9.2 Disposal

The device, accessories and packaging must be recycled in an environmentally friendly manner.

According to EU Directive 2002/96/EC on waste electrical and electronic equipment (WEEE) and its implementation in national legislation, electrical equipment that is no longer in use must be collected separately and recycled in an environmentally friendly manner. **Do not dispose electrical equipment with household waste!**

If you have any questions about disposal, please contact the manufacturer directly.



10. Appendix

10.1 Technical Specifications

	VIBA X.30	VIBA X.30 S	VIBA X.30 V
Power supply:	L1, N, PE; 230V / 50Hz	L1, N, PE; 230V / 50Hz	L1, N, PE; 230-240V / 50-60 Hz
Rated power:	0,9kW	0,9kW	0,9kW
Device fuse:	10 A	10 A	10 A
Line Fuse:	16 A C (RCD Typ B)	16 A C (RCD Typ B)	16 A C (RCD Typ B)
No load speed mixing unit:	- 660 1/min	- 690 1/min	- 660 1/min
Variable speed	no	no	6 intervals / speeds
Maximum mixing weight:	40 kg	40 kg	40 kg
Container height:	50 - 400 mm	50 - 400 mm	50 - 400 mm
Max. container footprint (w x d):	370 x 354 mm	370 x 354 mm	370 x 354 mm
Ambient temperature:	5 ... 30°C	5 ... 30°C	5 ... 30°C
Machine weight:	131 kg	131 kg	131 kg

Noise emission in accordance with 2006/42/EG

Sound pressure level L_{pA}	74,2 dB re 20 μ Pa	74,2 dB re 20 μ Pa	74,2 dB re 20 μ Pa
Sound power level L_{WA}	66,1 dB re 1 pW	66,1 dB re 1 pW	66,1 dB re 1 pW
Uncertainty K_{pA+WA}	3 dB	3 dB	3 dB

10.2 Dimensions

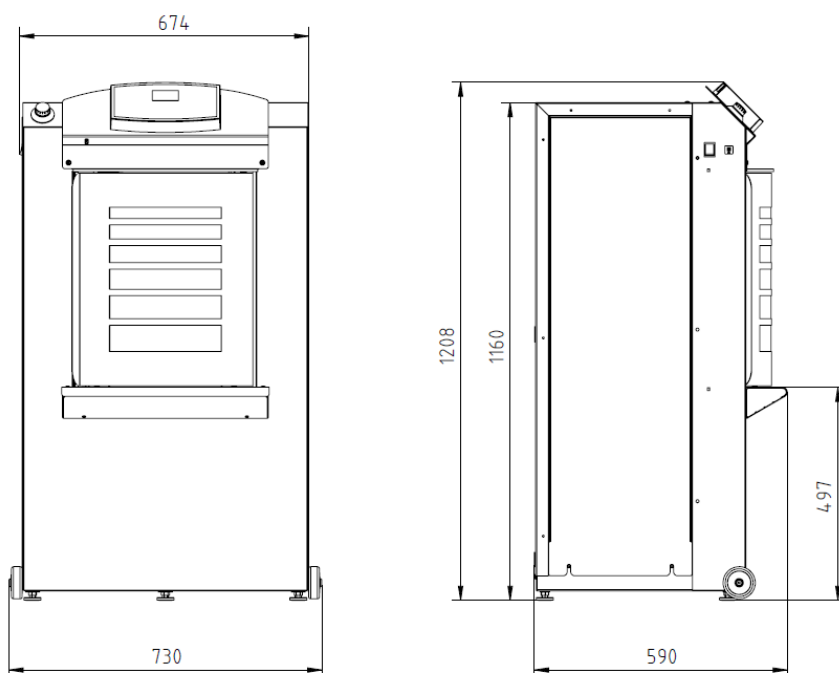

10.3 EC Conformity Declaration

We hereby declare under our sole responsibility that the products

VIBA X.30

are in conformity with the following European directives:

2006/42/EC; 2014/30/EU; 2011/65/EU

The following harmonized standards were applied:

EN 60204-1:2018, EN ISO 12100:2010, EN ISO 13849-1:2015, EN IEC 63000:2018
EN 61000-3-3:2013 + A1:2019, EN 61000-6-3:2007 + A1:2011, EN IEC 61000-3-2:2019, EN IEC 61000-6-2:2019

Please request technical information from:

EU: Collomix GmbH, Abt. Technische Entwicklung, Daimlerstr. 9, 85080 Gaimersheim, Deutschland
UK: Eurolink (Europe) Limited, Milestone House, Longcot Road, Shrivenham SN6 8AL

Gaimersheim, 02.12.2022

Alexander Essing
Managing Director



Manufacturer:

Collomix GmbH
Daimlerstr. 9
85080 Gaimersheim
Germany

Tel.: +49 (0)8458 32 98 – 0

Fax: +49 (0)8458 32 98 30

IMPORTANT

This declaration of conformity will lose its validity if any changes or modifications are made to the machine without the manufacturer's approval.

10.4 Warranty

For your rights in the event any rectifications become necessary, please read our General Delivery Terms and Conditions.

You find these on our website www.collomix.de. We are happy to send you our General Delivery Terms and Conditions on request.

Collomix GmbH
Daimlerstr. 9, 85080 Gaimersheim
Germany
Tel.: +49 (0)8458 32 98 - 0
Fax: +49 (0)8458 32 98 30
www.collomix.de
