

Instructions



Biaxial Mixer

BIAx 45P

**Keep this manual within immediate
reach of the machine**

Translation of the original instructions -en English

 **Collomix**

Version 1.8-18

Contents

1. Layout Drawings	4
1.1 Machine components	4
1.2 Operating and display components	5
2. About this document	6
2.1 Pictograms and symbols	6
3. For your safety.....	7
3.1 General Safety Information	7
3.2 Intended Use	7
3.3 Foreseeable Misuse	8
3.4 Qualifications of operating personnel	8
3.5 Safety-relevant components	9
3.6 Residual Risks	9
4. Equipment Description	9
5. Set-up and using the Mixer for the first time.....	10
5.1 Content	10
5.2 Set-up the equipment	10
5.3 Transport rollers	10
5.4 Mains connection	10
5.5 Activating the PERMA lubrication system	11
5.6 Trial run	11
6. Operation	12
6.1 Switching on the machine	12
6.2 Open the door (starting position)	12
6.3 Load a container	12
6.4 Starting the mixing cycle	13
6.5 Ending the mixing cycle	13
6.6 Close the door (parking position)	13
6.7 EMERGENCY STOP switch	13
7. Errors and Troubleshooting.....	14
7.1 Possible errors	14
7.2 E080 MU unlocked	15
7.3 Unlock door manually	16
7.4 Fuses on the device	16
7.4.1 Device fuse	16
7.4.2 DC fuse	16
8. Cleaning, maintenance, and service	17
8.1 Cleaning	17
8.2 Maintenance	17
8.3 Service	17
8.4 Replacing the rubber cord for handle	18
9. Expendable items	18
10. Storage, disposal.....	18
10.1 Storage	18
10.2 Disposal	18
11. Appendix	19
11.1 Technical Specifications	19
11.2 Dimensions	20
11.3 Roller conveyor module (optional)	21
11.4 EC Conformity Declaration	22
11.5 Warranty	22

1. Layout Drawings

1.1 Machine components



Machine components

1. Machine legs	5. Manual door release
2. Sliding door	8. Control panel CSE
3. Main switch and main fuse	7. Lower clamping plate
4. Emergency Stop	

1.2 Operating and display components



Button for DOOR

- OPEN door



Button E

- OPEN the mixing unit
- STOP – stop mixing cycle prematurely
- ACKNOWLEDGE messages



Button I

- **Mixing cycle I** (Factory settings 1:00 Minute)



Button II

- **Mixing cycle II** (Factory settings 1:00 Minute)



Button III

- **Mixing cycle III** (Factory settings 1:00 Minute)

For changing the Mixing times, please contact an authorized service technician.

2. About this document

This instruction uses symbols and labels, which should make it easier for you to find information swiftly. Please read the explanations in the following Section. Please read the safety and warning information in these instructions especially carefully. Safety information is in Chapter 2. You find information on warnings in the introduction of Chapters and before instructions.



Collomix GmbH owns the copyright of images and text.

Please read the operating instructions prior to first use. Pay attention to safety instructions. Keep for future use. This documentation is not subject to change services.

2.1 Pictograms and symbols

Warnings

The following symbols and signal words are used in this documentation.

Symbol	Meaning
<p>DANGER</p> 	This signal word is used, if death or severe physical injuries is the result of not paying attention to the corresponding precautionary measures.
<p>WARNING</p> 	This signal word is used, if death or severe physical injuries may result from not paying attention to the corresponding precautionary measures.
<p>ATTENTION</p> 	This signal word is used, if slight physical injuries occur from not paying attention to the corresponding precautionary measures.
<p>CAUTION</p>	This signal word is used, if malfunction of functions or property damages may occur from not paying attention to the corresponding precautionary measures.
<p>IMPORTANT</p>	This signal word is used for easing operation or for pointing to references.

Structure of warnings

DANGER

The first line describes the type and source of danger.

The second line describes the consequences which occur if no actions are taken to avert the danger.

➔ The last line describes the actions to take in order to avoid the danger.



WARNING

Danger of injury through disregard of safety symbols



Ignoring the warnings on the equipment and in the operating instructions can lead to injuries and additional risks.

➔ Pay attention to the warnings on the equipment and in the operating instructions.





The following special safety symbols are used in the appropriate text portions of these Operating Instructions.

Mandatory signs

Symbol	Explanation	Symbol	Explanation
	Please read the information		Disconnect from power after use Disconnect from power before opening the housing

Warning signs

Symbol	Explanation	Symbol	Explanation
	Warning from a danger zone		Danger of electric shock

Position numbers to the illustrations are stated in parenthesis in the text.

3. For your safety

The biaxial mixer was developed, manufactured, and tested in accordance with the basic safety requirements. Despite, there is an element of risk.

- Therefore, please read these Operating Instructions before working with the machine.
- Keep the Operating Instructions within immediate reach of the machine.
- Please hand the Operating Instructions to any subsequent owners.

3.1 General Safety Information

The basic safety information of this Chapter is supplemented by precise warnings in further chapters of the Operating Instructions.

3.2 Intended Use

The biaxial mixer is intended to mix:

- Colours
- Colour granulate
- Façade colours
- Industrial colours
- Plaster
- Other materials with low viscosity.

Any other or expanded use of the biaxial mixer is a non-intended and therefore, improper use. In this case, the safety mechanisms and the protection provided by them may be compromised. Collomix GmbH is not liable for any damages caused by it. Parts of the intended use are:

- Complying with all information in these Operating Instructions
- Complying with all safety information
- Complying with the inspection and maintenance work

3.3 Foreseeable Misuse

Any reasonably foreseeable misuse, which can be hazardous for the user, third parties, or for the biaxial mixer are:

- The use of the biaxial mixer and its accessories contrary to the intended use.
- The use of damaged containers or containers not suitable for mixing.
- The mixing of explosive substances.
- The use of substances, which react chemically with one another; in particular, expanding substances.
- The use of the equipment outside the physical use limitations described in the Chapter "Commissioning / Operating".
- The modification of the control software without the prior coordination with Collomix GmbH.
- Modifications on the biaxial mixer as well as add-ons and retrofits without the prior coordination with Collomix GmbH.
- Operating the system contrary to the requirements of the Operating Instructions concerning safety information, installation, operation, servicing, and maintenance, set-up, and malfunctions.
- Bridging or decommissioning of safety and protective actions of the system.
- Operating the system if malfunctions are obvious / with obvious malfunctions
- Repair, cleaning, and maintenance work without disconnecting the system from power.

WARNING

Danger of injury through improper modifications

Hazards exist through unauthorized modifications to the system and the use of third party spare parts.

- Use only original spare parts and accessories of the manufacturer.
- Do not change, add to, or retrofit the system without the consent of the manufacturer.



3.4 Qualifications of operating personnel

These Operating Instructions are directed toward operators and personnel with the following areas of competency:

Working area	Expertise
Installation, transport and storage	Specialised staff
Commissioning, decommissioning	Trained personnel
Operation	Trained personnel
Servicing and maintenance	Specialised staff
Troubleshooting	Specialised staff

Definition acc. to DIN EN 60204-1:

Trained personnel:

A person, who was instructed by an expert in the responsibilities he or she has been assigned and any possible hazards in case of improper behaviour and a person, who was trained in the necessary protective devices and protective actions, if needed.

Expert staff:

Persons who can evaluate the work assigned to them and recognize possible dangers on the basis of their specialised training, knowledge, experience, and familiarity with the relevant norms.

3.5 Safety-relevant components

The machine is equipped with various safety devices. These help to avoid dangers to body and life through electrical and mechanical impacts on the persons working with the biaxial mixer and they help to limit any material damages to the system.

- Do not bypass, remove, or render ineffective the safety equipment.
- Do not operate the system if the safety equipment is not complete or fully functional.

Closed housing

The housing, which can only be opened with tools, forms a fixed, separating safety device. Therefore, do not operate the machine if the rear panel or other covers are open; Unplug mains before opening this, to avoid a start.

Machine door with interlocking device

The door forms a locking, separating unit with interlocking device. The machine cannot be started when the door is open. The door is only released after the mixing process has ended and the mixing vessel is released. Never operate the machine if the machine door is damaged.

EMERGENCY STOP Switch

In emergencies the EMERGENCY STOP switch to halt the machine, if needed.

3.6 Residual Risks

If all precautions are taken, there may be obvious residual risks. Adhering to the safety instructions, the designated use, and the operating instructions as a whole can reduce residual risks!

4. Equipment Description

The biaxial mixer is a stationary mixing device for closed, tightly closing, round and oval vessels made of metal or plastic. It is suitable for mixing colours, colour concentrates, building and industrial lacquers, and other materials with low viscosity.

The area of application ranges from the colour wholesale to retail trade, the lacquer and chemical industry to any similar areas. This mixing device is especially suited as system component for colour dosing systems.

The container is automatically clamped into the machine and mixed by simultaneously rotation about its longitudinal and transverse axis.

The necessary mixing time and the suitability of the containers must be determined by mixing trials prior to use.

5. Set-up and using the Mixer for the first time

When setting up the machine, the applicable electrical requirements and the additional information in this Operating Instructions must be followed.

5.1 Content

The biaxial mixer is delivered with the following:

- These Operating Instructions
- A PERMA® lubrication cartridge
- A rubber band to secure the handles
- A power supply cord

5.2 Set-up the equipment

The machine is delivered on a wooden pallet packaged in recyclable cardboard. Check the packaging immediately upon receipt and the equipment when unwrapping it for any visual external defects. Keep all parts of the original packaging for a possible necessary return.

The machine shall be operated only by qualified personnel using suitable lifting equipment eg. a forklift truck to be lifted from the palette. Only move the fork in from the front or back to avoid damaging the transport rollers (5.3)!

Pay attention to the weight of the machine specified in 11.1 not to exceed the permissible load of the floor.

Do not operate the machine on the shipping pallet or on any other suitable sub-surfaces.

Before installation, ensure that there is a sufficiently large working area available in front of the machine. The doors of the machine may not protrude into aisles or travel paths when opened!

Check the level of alignment and the stability of the machine with a spirit level. Adjust any unevenness in the floor with the height-adjustable legs (1).

The optionally available roller conveyor module can be mounted using the illustration in 11.3.

5.3 Transport rollers

The mixer is equipped with two transport rollers on the bottom of the housing. These transport rollers can be made to protrude out of the mixing compartment by turning a screw on each side of the machine.

- Use a suitable tool size SW 17 to turn out the transport rollers on both sides of the machine.
- The door must be opened for the machine to be handled safely during transport. Secure the opened door with the hand against swinging
- Carefully tilt the mixer and move it.

When you are finished moving the machine, turn the transport rollers back.

5.4 Mains connection

Pay attention on proper protection of the electrical circuit such as described under 11.1 Only use Type B residual-current devices (RCD).

Place the mains cable in a way to prevent from stumbling or snagging.



Machine foot

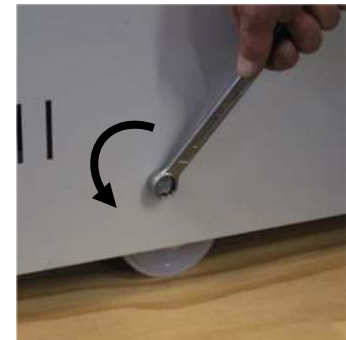

Transport rollers

5.5 Activating the PERMA lubrication system

The machine comes with a PERMA® long-time lubricator which is to be installed before you use the machine for the first time. Proceed as follows:

For an easier installation, first open the mixing unit completely. The lubrication nipple on the hub is on the left side.

Activate the PERMA cartridge by turning the **grey** activation screw into the cartridge until the holding clip is torn off completely. Remove also the black cap at the top of the cartridge.

Screw the cartridge into the adapter which was fitted to the hub at the factory.

Write the date of installation on the cartridge. The lubrication is guaranteed for approx. 12 months.

In multi-shift operation, in continuous operation with full load or with cycle times of more than 10 minutes, it may be necessary to increase the lubricant quantity. In this case, the PERMA © cartridge must be replaced at the **latest after 9 months**.

Please read the accompanying original PERMA documentation. Only use PERMA lubricating cartridges with **MOLYKOTE® 165 LT** grease!

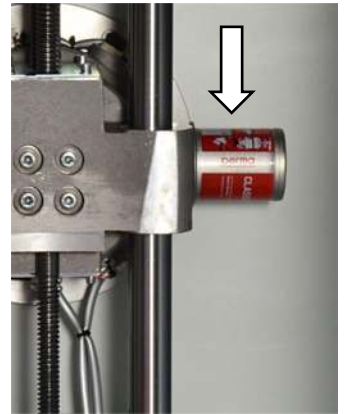

PERMA® lubricating

5.6 Trial run

A trial run with an empty mixing container must be conducted when first starting the machine or after maintenance and repair work in order to check the proper function of the machine.

WARNING

Risk of injury due to protruding parts

Parts may protrude from the equipment.

- Always work diligently on the equipment and in close proximity of the equipment.
 - If the machine is not used and turn it off on the main switch.
-



6. Operation

Prior to working with the machine, check all parts for their proper condition and function. Do not start the machine with defective or missing parts.

Check all safety-relevant structural components of the machine for proper function before starting it. Any defective or damaged parts must be replaced by qualified personnel prior to starting to work with it.

6.1 Switching on the machine

The machine is turned on using the main switch (3).

After an automatic initialisation, **READY** is shown on the display.

Any errors detected during initialisation are shown in text form on the display.

6.2 Open the door (starting position)

By pressing button **DOOR**, the door is opening. The display indicates **READY**, the machine is ready for mixing.

6.3 Load a container

Only use sufficiently stable and tight-closing vessels for mixing. In case of doubt, consult the manufacturer of the mixing vessels.

To place the container, proceed as follows:

- The machine must be in starting position, see 6.2
- Observe the weight and size limits of the mixing vessel. Never overload the machine!
- Place the container centrally on the mixing table. Place the handle to the rear side against the rubber band for handle fixation.
- If diameter is smaller than 270mm, secure the container handle with a rubber band or an adhesive.
- Use only undamaged containers, never stack containers!



Securing the handle with a rubber band

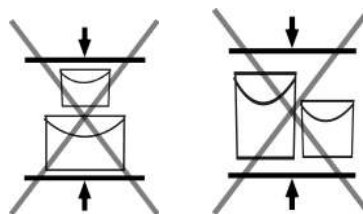
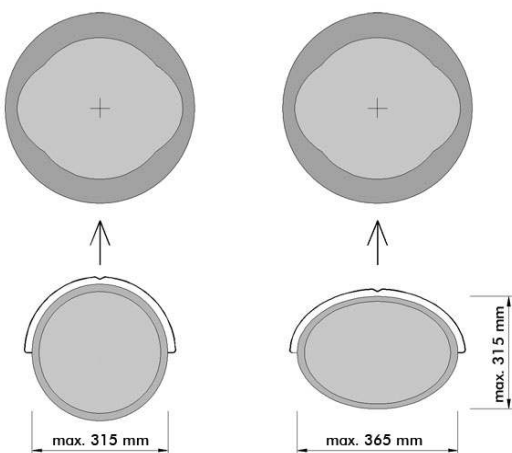

Do not stack containers!

6.4 Starting the mixing cycle

Start the mixing cycle by pressing one of the timer buttons I, II or III.

The corresponding mixing time is indicated in the LCD display above the buttons.

The doors are closing. The mixing container is clamped in place and the mixing cycle is started automatically.

The remaining mixing time is indicated in the LCD display as the mixing cycle progresses.

6.5 Ending the mixing cycle

After the selected time is over

The mixing process is automatically stopped. The mixing unit is moved to the 12 o'clock position and opens automatically. The door is opened by spring force, and the container can be removed.

Before the selected time is over

The mixing process can be stopped early by pushing the E-button.

6.6 Close the door (parking position)

When the machine is not used or before switching off the machine after work, the doors shall be closed by pressing the **DOOR** button.

When done working, switch the machine off at the mains (3).

6.7 EMERGENCY STOP switch

In dangerous situations, the machine can be turned off with the EMERGENCY STOP switch.

After the **EMERGENCY STOP button** is pressed, the mixing unit will coast to a standstill and remain in this position. **The mixing unit is not moved automatically to the 12 o'clock position!**

Reset the EMERGENCY STOP switch

The EMERGENCY STOP switch must be reset by hand.

- Rotate the red control element clockwise.
- After you reset the EMERGENCY STOP switch, reset the message in the display by pushing the E-button.

DANGER

Danger of death by dangerous voltage

There is a residual electrical energy in lines and equipment after the EMERGENCY STOP switch is used. The EMERGENCY STOP switch does not disconnect the machine from the mains voltage.

- If maintenance or repair work is carried out on the machine, always unplug the power cord.



After reset of the EMERGENCY STOP switch, the mixing unit must be manually turned into 12 o'clock position in order to release the mixing container. Please follow therefore the instruction at 7.2 E080 MU unlocked

7. Errors and Troubleshooting

The troubleshooting tables in this Chapter will help you to determine whether you can troubleshoot yourself or whether you need to call customer service.

DANGER

Danger of death by dangerous voltage

Please note that all maintenance and servicing jobs must be left strictly to authorized and suitably trained expert staff. This applies in particular to those jobs printed on a gray background which have to be performed with the housing open.



7.1 Possible errors

Fault	Description	Machine condition	Solutions
E010	Door open	• Door open	• Close door
		• Door closed	• Check the door lock • Check the power cord / plug to the door lock.
E020	EMERGENCY STOP activated	• EMERGENCY STOP button pushed	• Release the EMERGENCY STOP
		• EMERGENCY STOP button not pushed	• Check the switch of the EMERGENCY STOP button • Check the power cord / plug to the EMERGENCY STOP button.
E050	Defective container	• Container is defect	• Container is unstable
			• Check clamping pressure, if necessary adjust
E070	Mixing Unit locked	• Latching pin blocked	• The latching pin is blocked – clean and lubricate, replace if necessary
		• Latching pin released	• Check the lead/connector to the switch of the mixing unit lock. • The switch of the mixing unit lock is defective.
E080	Mixing Unit unlocked	• Latching pin blocked	• The mixing unit is not 12 at o'clock position • Check the lead/connector to the switch of the latching pin • The switch of the mixing unit lock is defective
		• Latching pin released	• Check the lead/connector to the switch of the mixing unit lock. • The switch of the mixing unit lock is defective
E120	Mixing speed too low	• The mixing unit rotates	• Check the lead/connector to the "position" proximity switch • The "position" proximity switch is defective
		• The mixing unit does not rotate	• Check frequency converter • Check the door safety switch • Check the main motor
E130	Mixing speed too high	• The mixing unit rotates too fast	• Decrease the motor speed
E150	Error clamp motor	• The mixing container is not clamped	• Check the clamp motor • Check the lines to the clamp motor • Check the control

Fault	Description	Machine condition	Solutions
E170	Error door lock		<ul style="list-style-type: none"> Close door completely
			<ul style="list-style-type: none"> Check the door lock Check the connection of the door lock Check door motor
E180	Door is not open	<ul style="list-style-type: none"> The door is not open 	<ul style="list-style-type: none"> Open door with the DOOR button
		<ul style="list-style-type: none"> The mixing container is clamped 	<ul style="list-style-type: none"> Check the door lock Check the connection of the door lock Check door motor
E190	Fuse blown		<ul style="list-style-type: none"> Turn the machine off and wait one minute until the fuse can be pushed in again.

7.2 E080 MU unlocked

The mixing unit was not positioned and fixed in the 12o'clock position.

This condition occurs upon actuation of the EMERGENCY STOP button or upon interruption of the power supply during the mixing process.

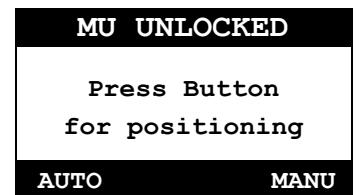

AUTO

With the container **clamped** or the mixing unit **not loaded**, the mixing unit can be automatically positioned and fixed with the help of **Button I (Auto)**

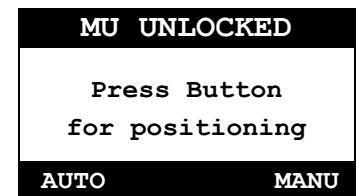

MANU

With the mixing container unclamped, the mixing unit must be positioned manually.

Upon actuation of Button III (MANU), the door can be opened by pressing the DOOR button.

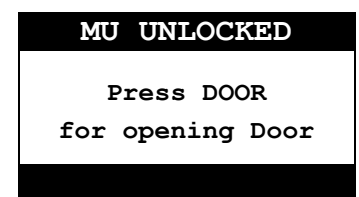

Remove mixing unit from the mixing space and fix mixing unit manually in 12o'clock position

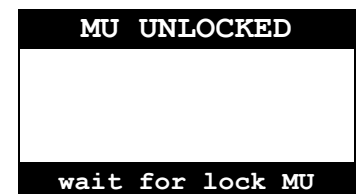

Quit manual positioning by pressing the E button

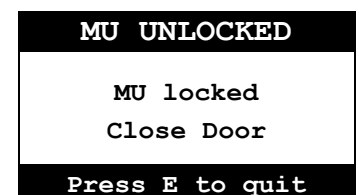

7.3 Unlock door manually

The machine is equipped with a safety lock, which locks the door automatically after it is closed. In the event of a malfunction or power outage, the door can be locked manually.

- Disconnect the machine from the mains by pulling out the mains plug.
- Remove the plastic stopper (5) from the door unlocking device.
- Use a screwdriver to move the unlocking device in direction of the arrow.
- Open the door.



Door unlocking device

WARNING

Risk of injury by machine parts that continue to rotate

When activating the manual door release, the mixing process is interrupted automatically. The mixing unit will run for a few seconds up to a complete standstill.

- Use the manually door unlocking device only in case of emergency.
- Before using the manually door unlocking device, always disconnect the machine from the mains by pulling out the mains plug.
- Never use the manually door unlocking device whilst the mixing unit is turning.



7.4 Fuses on the device

7.4.1 Device fuse

If line voltage is available but the power button does not light up, the cause may be a faulty device fuse.

The device fuse is located in the mains connection on the back of the machine. Only use 5x20mm, 230V/10AT fuses to replace a blown fuse.

If the device fuse is tripped again, there is a defect in the control unit. If this is the case, contact an authorised service partner to correct the error.



Device fuse

7.4.2 DC fuse

If the power button is on, but nothing is showing on the display of the operating unit, the cause may be a tripped DC fuse.

The DC fuse is located next to the power button. After the fuse is tripped, wait at least one minute, and only then press the pin back in until it locks into place.

If the device fuse is tripped again, there is a defect in the control unit. If this is the case, contact an authorised service partner to correct the error.



DC fuse

8. Cleaning, maintenance, and service

It is necessary to check, clean, and service the machine regularly to ensure continuous function. Unplug the machine from power by pulling the plug before all cleaning, maintenance, and repair work is done on the machine.



8.1 Cleaning

Remove any spilled mixed compound immediately from the interior of the machine. For this purpose, use a rag or a scraper. Be careful not to damage any connections or sensors.

After cleaning the splash guard, apply a thin film of spray oil in order to avoid any sticking of color splashes.

Soiled threaded spindles (4) can be cleaned with a rag or a brass wire brush. The threaded spindles must be re-lubricated with **MOLYKOTE® BR 2 plus** after cleaning.

Clean the guide columns (1) with nitro diluent or another suitable solvent. For stubborn dirt, 400 grit sandpaper can be used. After cleaning, lubricate the guide columns with oil (for example, SAE 15W30 engine oil).

Never use WD 40 or silicone or Teflon based lubricant!

CAUTION

Damage to the machine through dry run ball bearings

If you clean the machine with a high-pressure washer, the lubricant is washed out from the ball bearings and they run dry.

- Never clean the machine with a high-pressure washer or similar.
- Replace dry-run ball bearings immediately.



8.2 Maintenance

Every week:

- Remove any dirt from the machine.
- Apply a thin coat of lubricating oil at the two guide columns (1).
- Check the rubber cord for handle safeguard (3), replace if it's worn or damaged.

Every 6 months:

- Check the PERMA lubricating cartridge (2) and replace it if necessary.
- Lubricate the threaded spindle (4) and the spindle shaft with MOLYKOTE® BR 2 plus.
- Check that the lock pin of the mixing unit moves smoothly.
- Check that all ball bearings move smoothly. Ball bearings are to be found on the two clamping jaws, on the drive shaft at the transmission gear and on the clamping tables.

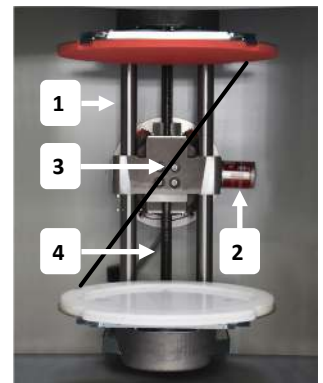

1 Colonnes de guidage
2 Graisseur PERMA
3 Vis sans fin
4 Élastique

8.3 Service

If service is required, please consult the customer service or the manufacturer of the machine.

DANGER

Danger of death by dangerous voltage

Do not open the housing or remove any safety equipment of the machine. Please note that all maintenance and servicing jobs must be left strictly to authorized and suitably trained expert staff. The proper state of all safety equipment and electrical equipment is to verify and document after the repair.

- Only use original spare parts.
- Do not modify or change safety-related parts!
- Any additional components added may not impair safety and must be approved by the manufacturer.



8.4 Replacing the rubber cord for handle

- Open the door by pressing the button **DOOR** button.
- Unplug the machine from power by pulling the plug.



Thread the end of the rubber cord through the hole at the upper clamping plate. Put on the washer and tie the rubber cord.

Hook the plastic carabiner at the left side of the bottom clamping plate.

9. Expendable items

The following expendable items are available for the device:

Part	Article no.:
Rubber cord for handle safeguard	72701
Bag 10 pcs. of rubber ring for the handle safeguard 200 mm Ø	61326
Bag 10 pcs. of rubber ring for the handle safeguard 160 mm Ø	61327
Bag 10 pcs. of rubber ring for the handle safeguard 140 mm Ø	61328
Molykote® BR2 plus grease 100 g	61298
PERMA® long-time lubricator cartridge - grey screw, 12 month	72047
PERMA® long-time lubricator cartridge - red screw, 6 month	72063

Spare parts are available under www.collomix.de.

10. Storage, disposal

10.1 Storage

The storage area should be cool and dry in order to prevent corrosion on the individual parts of the machine.

The room temperature of the storage area must be constantly above freezing.

- Package the device to prevent any damages through outside impacts during storage.
- If necessary, use cardboard and other packaging material.
- Secure the machine against unintentional tilting and instability.

10.2 Disposal

The transport package is made of recyclable material. Please dispose this material accordingly.

At the end of the useful life, the machine must be properly disposed to return the used raw materials to the recycling loop. Please contact the manufacturer directly for any questions concerning disposal.

11. Appendix

11.1 Technical Specifications

BIAx 45P	
Power supply:	230V / 50Hz
Rated power:	1,5 kW
Device fuse:	10AT
Line fuse:	16 A C (RCD Typ B)
Speed of mixing unit:	- 140 UpM
Mixing weight:	max. 40 kg
Container height:	120 – 450 mm
Container diameter:	max. \varnothing 365 mm
Ambient temperature	5 ... 30°C
Machine weight:	227 kg

Noise emission in accordance with 2006/42/EG

Sound pressure level L_{pA}	64 dB re 20 μ Pa
Sound power level L_{WA}	75 dB re 1 pW
Uncertainty K_{pA+WA}	3 dB

11.2 Dimensions

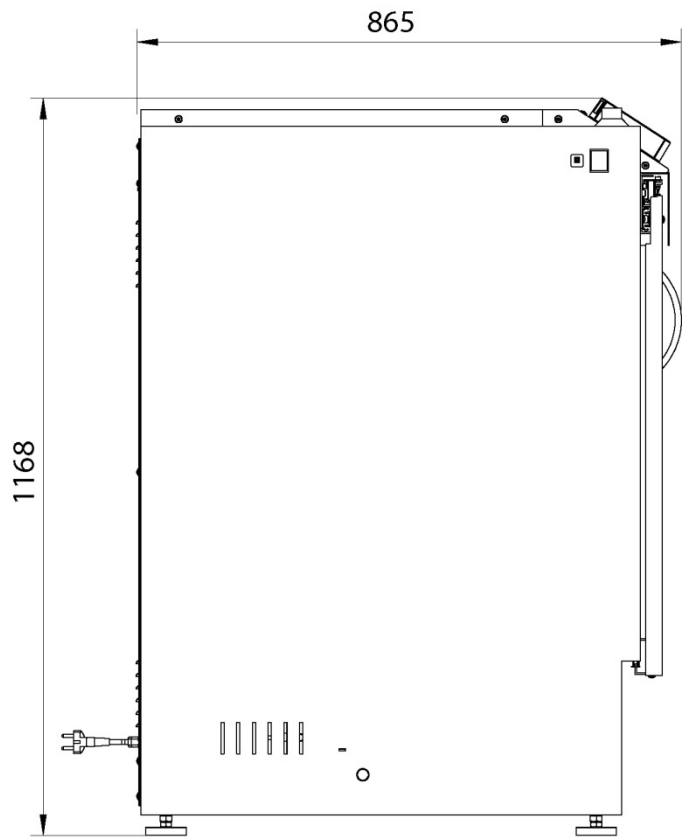
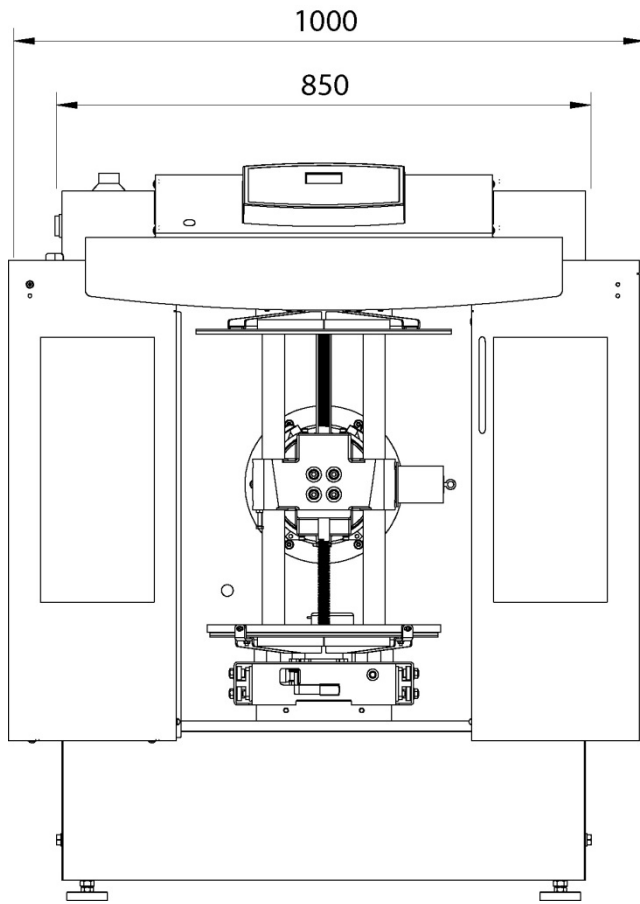

11.3 Roller conveyor module (optional)

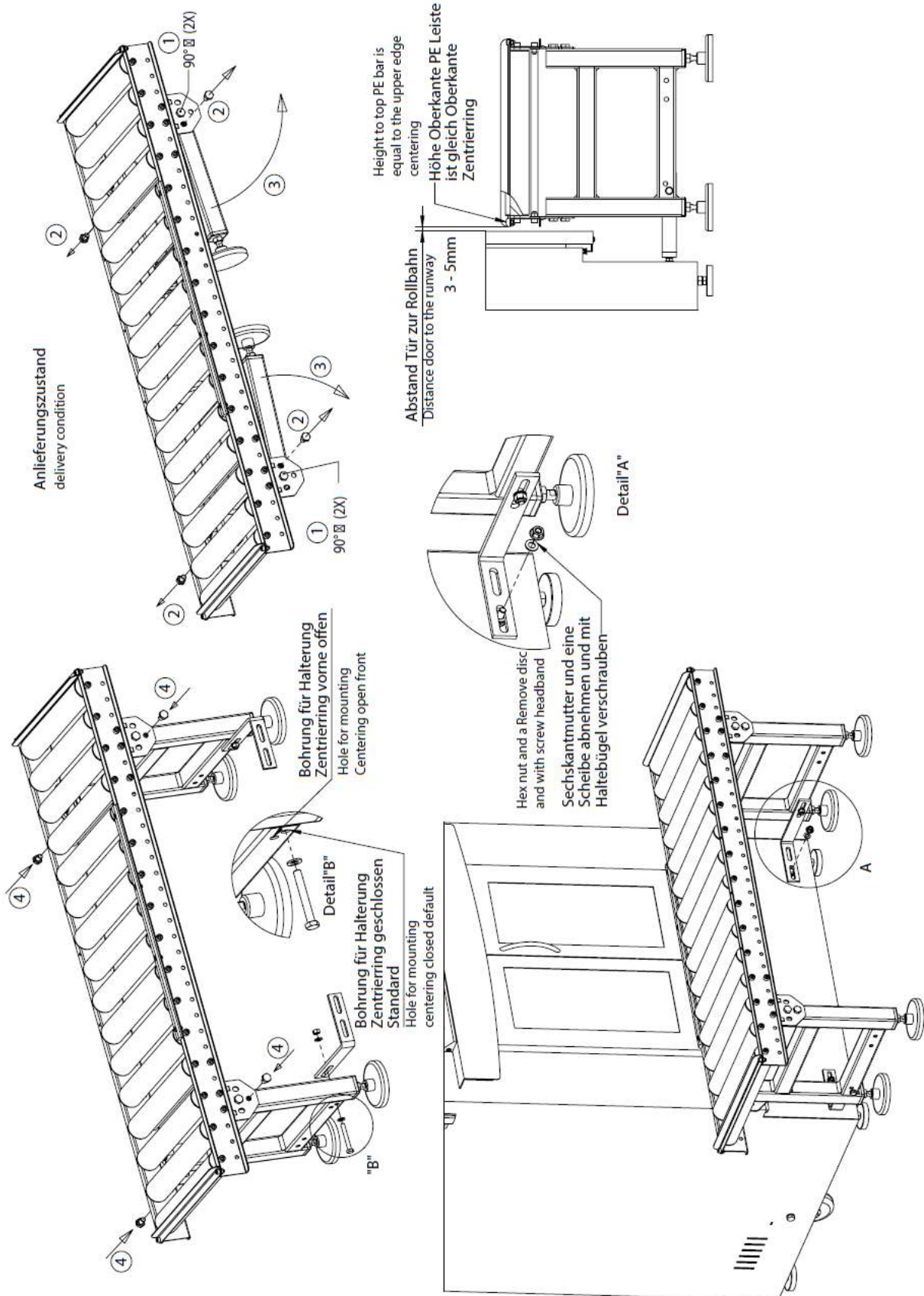

11.4 EC Conformity Declaration

We hereby declare under our sole responsibility that the products

BIAX 45P

are in conformity with the following European directives:

2006/42/EC; 2014/30/EU; 2011/65/EU

The following harmonized standards were applied:

EN 60204-1:2006 + A1:2009 + AC:2010, EN ISO 12100:2010, EN ISO 13849-1:2008 + AC:2009,
EN 55011:2009 + A1:2010, EN 61000-3-2:2014, EN 61000-3-3:2013, EN 61000-6-2:2005 + AC:2005

Please request technical information from:

Collomix GmbH, Abt. Technische Entwicklung, Daimlerstr. 9, 85080 Gaimersheim, Deutschland

Gaimersheim, 2016-04-20

Alexander Essing
Managing Director



Manufacturer:

Collomix GmbH
Daimlerstr. 9
85080 Gaimersheim
Germany

Tel.: +49 (0)8458 32 98 – 0

Fax: +49 (0)8458 32 98 30

IMPORTANT

This declaration of conformity will lose its validity if any changes or modifications are made to the machine without the manufacturer's approval.

11.5 Warranty

For your rights in the event any rectifications become necessary, please read our General Delivery Terms and Conditions.

You find these on our website www.collomix.de. We are happy to send you our General Delivery Terms and Conditions on request.

Collomix GmbH
Daimlerstr. 9, D-85080 Gaimersheim
Germany
Tel.: +49 (0)8458 32 98 - 0
Fax: +49 (0)8458 32 98 30
www.collomix.de
